

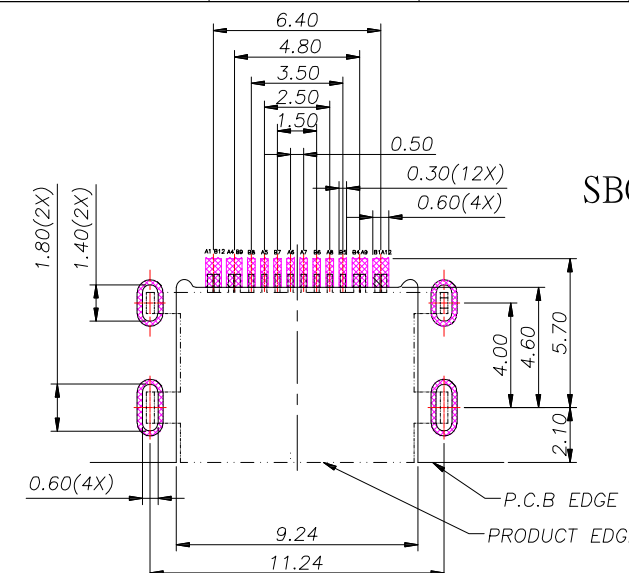

SBC-160M3A-20x-S412

鍍層厚度 :

Blank : 1u"
2 : 15u"
3 : 30u"

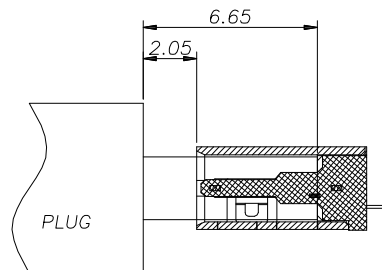
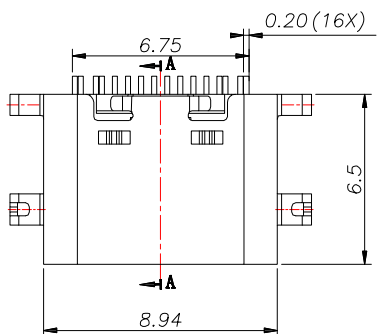

RECOMMENDED PCB LAYOUT

USB TYPE-C PIN ASSIGNMENTS

PIN NUMBER	SIGNAL NAME	PIN NUMBER	SIGNAL NAME
A1	GND	B12	GND
A4	VBUS	B9	VBUS
A5	CC1	B8	SBU2
A6	Dp1	B7	Dn2
A7	Dn1	B6	Dp2
A8	SBU1	B5	CC2
A9	VBUS	B4	VBUS
A12	GND	B1	GND

SPECIFICATIONS

Electrical:

- 1.Rating: 5.0V , 3.0 A
- 2.Contact Resistance: 40 mΩ Max
- 3.Insulation Resistance: 100 MΩ Min

Mechanical:

- 1.Connector Mate and Unmate Force
 - 1.1 Mate force: 5~20 N
 - 1.2 Unmate force: 8~20 N

Material:

- 1.Housing: LCP
- 2.Contact: Copper Alloy
- 3.Shell: SUS

Finish:

- 1.Contact: Plated Gold in Mating Area ;
Tin Plated on Solder Balls ;
Nickel under plated overall
- 2.Shell: Nickel under Plated surface layer

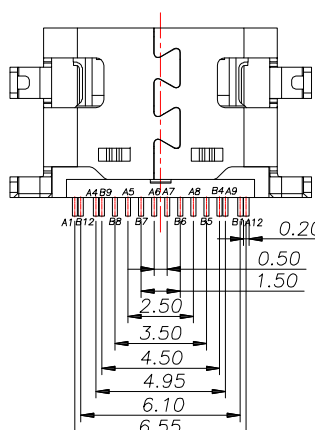
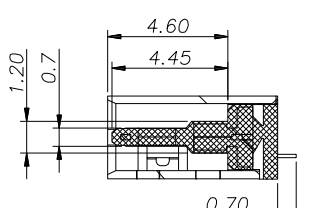
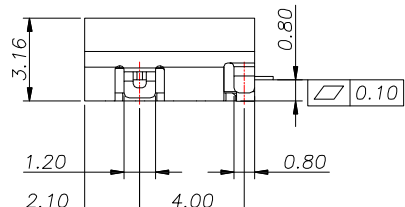
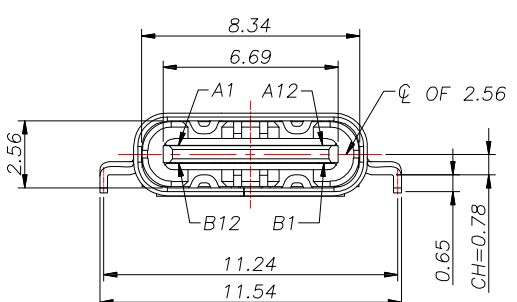

东莞市高迪电子有限公司
Dong Guan KDRR Electronic Switch Jack Co., Ltd.

TOLERANCE UNLESS OTHERWISE STATED:

Up to 5 ±0.2
Above 5 ~ 15 ±0.3
Above 15 ~ 30 ±0.4
Above 30 ~ 50 ±0.5
Angle ±0.3°

3RD. ANGEL'S



UNITS

MM

DRAWN BY:	DATE	MAT'L	TITLE	CONNECTOR
Jack Lu	09/18/19			
CHECKED BY:	DATE	FINISH	MODLE	USB TYPE C 2.0 沉板 0.8mm
Jacky Chen	09/18/19			
APPROVED BY:	DATE	SCALE	DWG NO.	SBC-160M3A-20x-S412
Tony Kao	09/18/19	1 : 1		
		SHEET NO.	PART NO.	SBC-160M3A-20x-S412
		1 of 1		

ITEM NO.	DESCRIPTION	DRAWN	DATE